ALPHA WIRE COMPANY
CUSTOMER PRODUCT SPECIFICATION

Part Number: 783
Page 1 of 2 Pages

Issue: 3
Issue Date: 5/20/2004
Effective Date: 6/30/2004

A. Cordage Construction

- 1) Conductor
 - a) Material Bare Copper Per ASTM B-3
 - b) AWG, Stranding 16, 26/30; Finer stranding may be used.

- 2) Insulation
 - a) Material Rubber
 - b) Min. Avg. Wall Thickness 0.030
 - c) Nominal Diameter 0.120

- 3) Core Assembly
 - a) Number of Conductors 3
 - b) Color Code Black, White & Green/Yellow or Black, White & Green within Munsell® Component extended limits of deviation.
[Note: The stripe of the Green/Yellow insulation shall be 50% +/- 20%.]
 - c) Fillers Optional
 - d) Separator Tissue Paper

- 4) Jacket
 - a) Material Rubber
 - b) Surface Finish Smooth, non-striated
 - c) Min. Avg. Wall Thickness 0.030
 - d) Nominal Diameter 0.340
 - e) Color Black; within Munsell® Component limits of deviation
 - f) UL, CSA Type SJ**, Minimum
 - g) Jacket Marking Per UL Standard 62 and CSA C22.2 No. 49.

** Cordage Types with a UL/CSA rating greater than Type SJ may be substituted.

B. Cord Configuration

- 1) End 1 Molded Vinyl Grounding Plug, NEMA 5-15P
- 2) End 2 Jacket Stripped 1.5" +/- .125"
Insulation Stripped 0.625" +/- 0.0625"
- 3) Mold Color Black
- 4) Overall Length 108" +/- 1"

ALPHA WIRE COMPANY
CUSTOMER PRODUCT SPECIFICATION

Part Number: 783
Page 2 of 2 Pages

Issue: 3
Issue Date: 5/20/2004
Effective Date: 6/30/2004

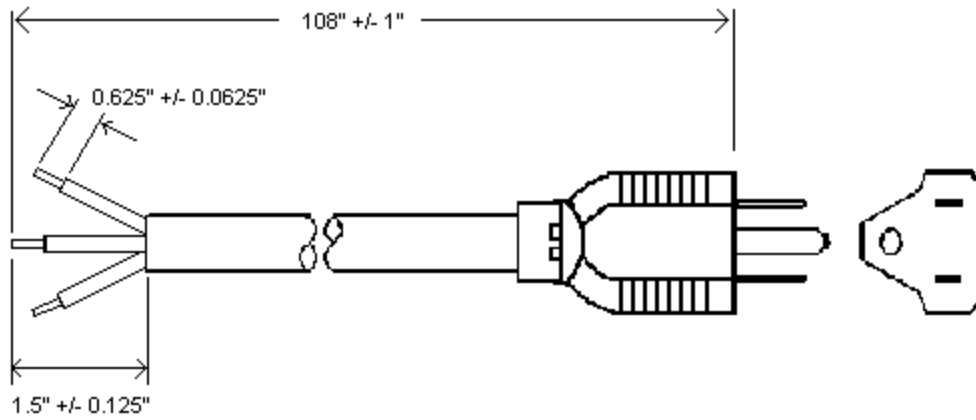

C. Industry Approvals and Ratings

- | | |
|-----------------------|------------------|
| 1) UL | UL Standard 817 |
| 2) CSA | CSA C22.2 No. 21 |
| 3) Voltage Rating | 125 Vrms |
| 4) Current Rating | 13 Amps |
| 5) Temperature Rating | 60°C, Minimum |